

NOTES:

1. RoHS: COMPLIANT

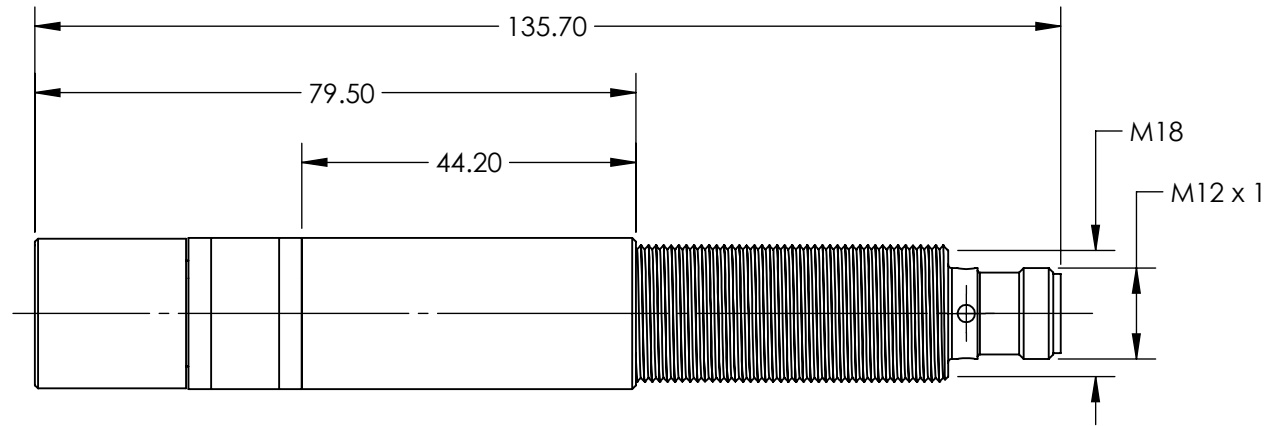
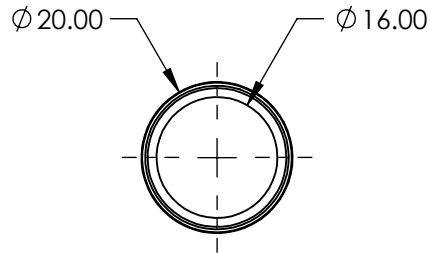

SPECIFICATIONS SUBJECT TO CHANGE WITHOUT NOTICE
DIMENSIONS ARE FOR REFERENCE ONLY

**FOR INFORMATION ONLY:
DO NOT MANUFACTURE
PARTS TO THIS DRAWING**

EO® Edmund Optics®

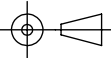
THIRD ANGLE PROJECTION 		TITLE	40mW, 20° Uniform Line, Harsh Environment Green Diode	
ALL DIMS IN	mm	DWG NO	64831	SHEET 1 OF 1