

FOCAL LENGTH (EFL): $6 \pm 0,06$
 BACK FOCAL LENGTH (BFL): $3,92$

SURFACE A	SURFACE B	SURFACE C
$\varnothing e 3,6$	$\varnothing e 3,6$	$\varnothing e 3,6$
CEMENT: NOA 61 OR EQUIVALENT		

PROTECTIVE CHAMFERS AS NEEDED		FIRST ANGLE PROJECTION	 Edmund Optics®				
ROHS: COMPLIANT	SCALE: NONE $\lambda = 587,6\text{nm}$						
SPECIFICATIONS SUBJECT TO CHANGE WITHOUT NOTICE. DIMENSIONS ARE FOR REFERENCE ONLY			TITLE	4mm Dia, x 6mm FL, VIS 0 Coated, Achromatic Lens			
FOR INFORMATION ONLY: DO NOT MANUFACTURE PARTS TO THIS DRAWING			ALL DIMS IN:	mm	DWG NO	63702	
INDICATIONS IN ACCORDANCE WITH ISO 10110				SHEET SIZE	A4	SHEET	1 OF 3

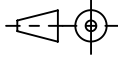
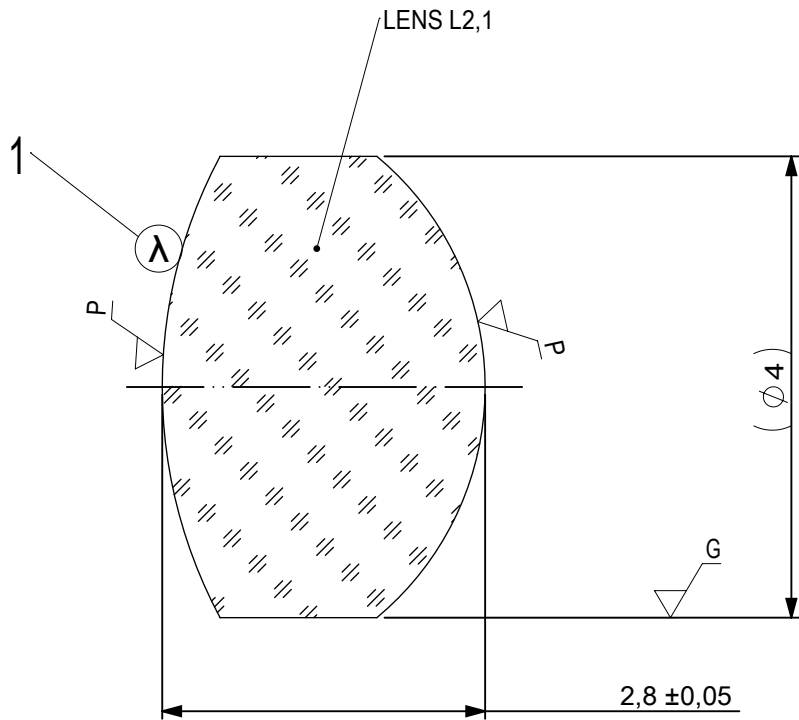

1 AR COATING: VIS 0°
R(AVG) ≤ 0,4% FROM 425-675nm @ 0° AOI

LEFT SURFACE	MATERIAL	RIGHT SURFACE
R 4,24±0,004 CX Øe 3,6 3/ 3 (0,5) λ=632,8 nm 4/ - 5/ 20 - 10 (MIL-PRF-13830B) 6/ -	GLASS N-BaF10 670/472	R 2,6±0,003 CX Øe 3,6 3/ 3 (0,5) λ=632,8 nm 4/ - 5/ 20 - 10 (MIL-PRF-13830B) 6/ -

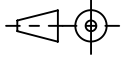
PROTECTIVE CHAMFERS AS NEEDED		FIRST ANGLE PROJECTION	 Edmund Optics®		
ROHS: COMPLIANT	SCALE: NONE λ = 587,6nm				
SPECIFICATIONS SUBJECT TO CHANGE WITHOUT NOTICE. DIMENSIONS ARE FOR REFERENCE ONLY			TITLE	4mm Dia, x 6mm FL, VIS 0 Coated, Achromatic Lens	
FOR INFORMATION ONLY: DO NOT MANUFACTURE PARTS TO THIS DRAWING			ALL DIMS IN:	mm	DWG NO
INDICATIONS IN ACCORDANCE WITH ISO 10110				SHEET SIZE	A4
					SHEET 2 OF 3

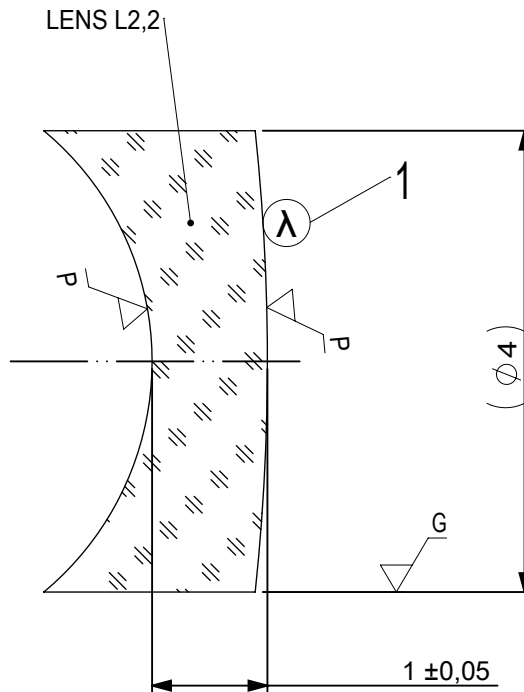

1 AR COATING: VIS 0°
R(AVG) ≤ 0,4% FROM 425-675nm @ 0° AOI

LEFT SURFACE	MATERIAL	RIGHT SURFACE
R 2,6±0,003 CV Øe 3,6 3/ 3 (0,5) λ=632,8 nm 4/ - 5/ 20 - 10 (MIL-PRF-13830B) 6/ -	GLASS N-SF10 728/284	R 18,9±0,019 CX Øe 3,6 3/ 3 (0,5) λ=632,8 nm 4/ - 5/ 20 - 10 (MIL-PRF-13830B) 6/ -

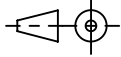
PROTECTIVE CHAMFERS AS NEEDED		FIRST ANGLE PROJECTION			
ROHS: COMPLIANT	SCALE: NONE λ = 587,6nm				
SPECIFICATIONS SUBJECT TO CHANGE WITHOUT NOTICE. DIMENSIONS ARE FOR REFERENCE ONLY			TITLE 4mm Dia, x 6mm FL, VIS 0 Coated, Achromatic Lens		
FOR INFORMATION ONLY: DO NOT MANUFACTURE PARTS TO THIS DRAWING			ALL DIMS IN: mm	DWG NO 63702	SHEET SIZE A4
INDICATIONS IN ACCORDANCE WITH ISO 10110					