

NOTES:

1. SUBSTRATE: FUSED SILICA
2. COATING:
S1 & S2: R(ABS) <0.5% @ 370 - 550nm
3. CENTERING: < 3 ARCMIN
4. RoHS: COMPLIANT

**FOR INFORMATION ONLY:
DO NOT MANUFACTURE
PARTS TO THIS DRAWING**

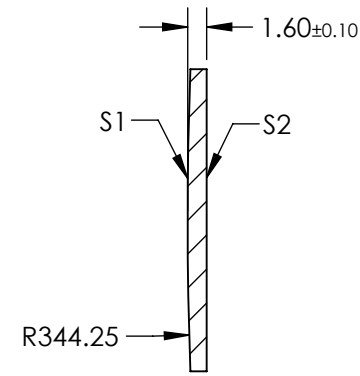
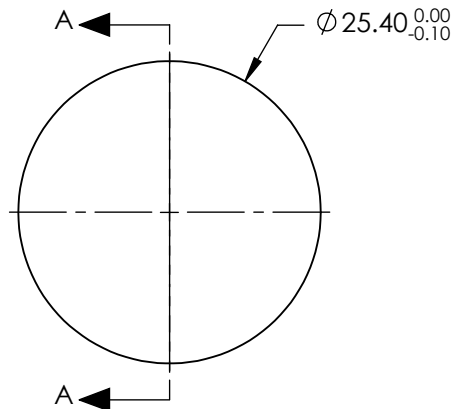

SECTION A-A

SPECIFICATIONS SUBJECT TO CHANGE WITHOUT NOTICE
DIMENSIONS ARE FOR REFERENCE ONLY

	S1	S2
SHAPE	CONVEX	PLANO
SURFACE QUALITY	20-10	20-10
CLEAR APERTURE	Ø22.86	Ø22.86
BEVEL	PROTECTIVE AS NEEDED	PROTECTIVE AS NEEDED

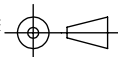
EFL: 750.87mm		 Edmund Optics®	
BFL: 749.78mm			
		TITLE	25.4mm Diameter x 750mm FL, 370-550nm Coated, Ultrafast Thin PCX Lens
ALL DIMS IN	mm	DWG NO	11686
			SHEET 1 OF 1