

NOTES:

1. SUBSTRATE:
FUSED SILICA
2. SURFACE S2 TO BE PARALLEL TO SURFACE S1 TO WITHIN <5 ARCSEC
3. COATING (APPLY ACROSS COATING APERTURE):
S1 & S2: NIR II (750-1550nm)
R(ABS) ≤1.5% @ 750 - 800nm
R(ABS) ≤1.0% @ 800 - 1550nm
R(AVG) ≤0.7% @ 750 - 1550nm
4. WAVELENGTH RANGE: 750 - 1550nm

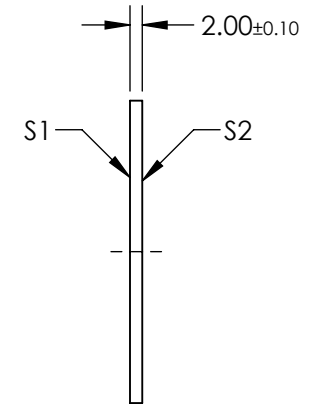
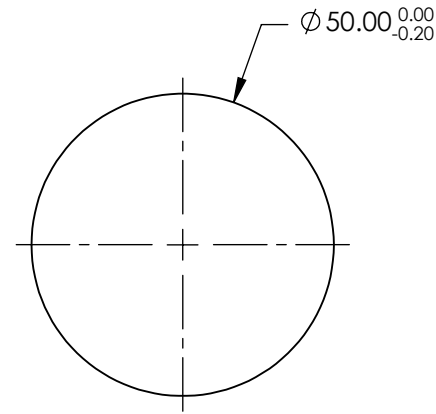

**FOR INFORMATION ONLY:
DO NOT MANUFACTURE
PARTS TO THIS DRAWING**

SPECIFICATIONS SUBJECT TO CHANGE WITHOUT NOTICE
DIMENSIONS ARE FOR REFERENCE ONLY

	S1	S2
SHAPE	PLANO	PLANO
SURFACE QUALITY	20-10	20-10
TRANSMITTED WAVEFRONT (P-V)	0.10 WAVE	0.10 WAVE
CLEAR APERTURE	Ø40.00	Ø40.00
BEVEL	PROTECTIVE AS NEEDED	PROTECTIVE AS NEEDED



ALL DIMS IN

mm



Edmund Optics®

TITLE

50mm Dia., 2mm Thick, NIR II Coated λ/10
Fused Silica Window

DWG NO

11907

SHEET
1 OF 1