

NOTES:

1. MATERIAL: BLACK MATTE ANODIZED ALUMINUM
2. RoHS: COMPLIANT

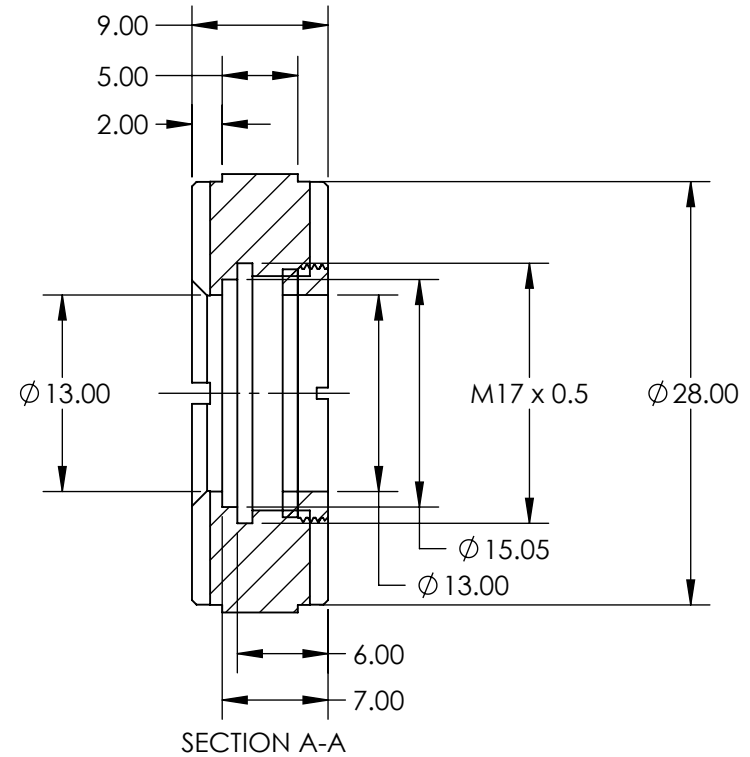
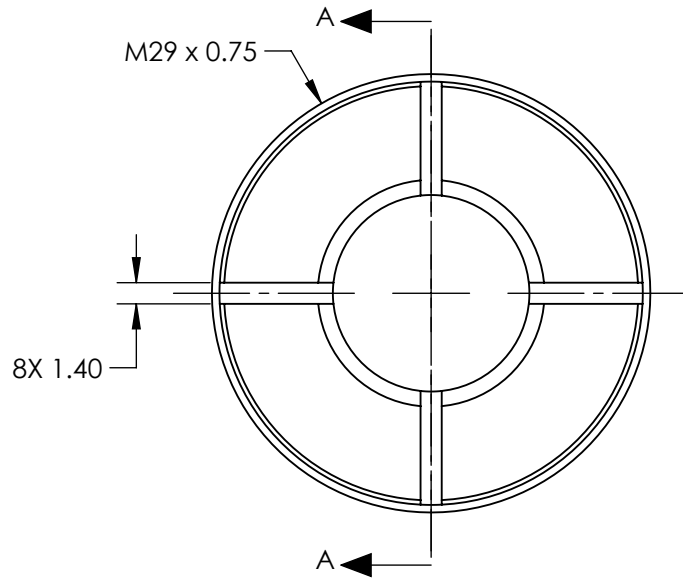
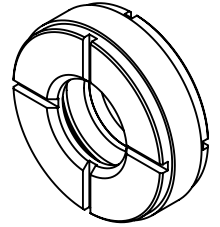

SPECIFICATIONS SUBJECT TO CHANGE WITHOUT NOTICE
DIMENSIONS ARE FOR REFERENCE ONLY

**FOR INFORMATION ONLY:
DO NOT MANUFACTURE
PARTS TO THIS DRAWING**

EO® Edmund Optics®

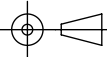
THIRD ANGLE PROJECTION 		TITLE	M29 TUBE 15S	
ALL DIMS IN	mm	DWG NO	38752	SHEET 1 OF 1