

NOTES:

1. SUBSTRATE:
Alumoscilate Glass Embedded with Silver Ions
2. COATING (APPLY ACROSS COATING APERTURE)
S1 & S2: BBAR (780-840nm)
R(AVG) < 0.5% @ 810nm ±30nm
3. EFL: 0.93
4. f/# : 0.93
5. NUMERICAL APERTURE: 0.54
6. DESIGN WAVELENGTH: 810nm
7. WORKING DISTANCE: 0mm
8. ROHS: COMPLIANT

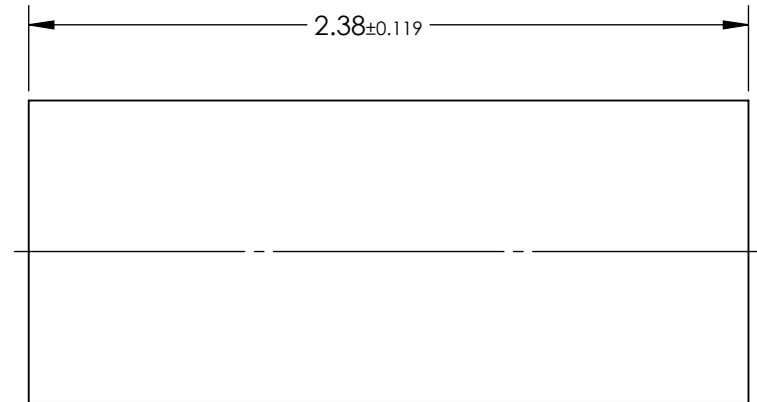
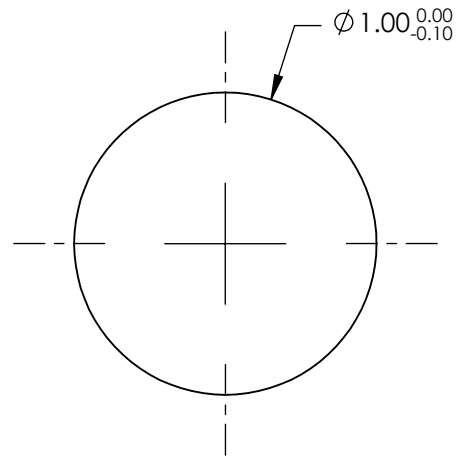

**FOR INFORMATION ONLY:
DO NOT MANUFACTURE
PARTS TO THIS DRAWING**

SPECIFICATIONS SUBJECT TO CHANGE WITHOUT NOTICE
DIMENSIONS ARE FOR REFERENCE ONLY

EO® Edmund Optics®

	S1	S2	THIRD ANGLE PROJECTION		TITLE	1.0mm Dia, 810nm DWL, 0.0mm WD, NIR Coated, GRIN Lens	
SHAPE	PLANO	PLANO	ALL DIMS IN	mm	DWG NO	64541	SHEET 1 OF 1
SURFACE QUALITY	40-20	40-20					
CLEAR APERTURE	Ø0.9	Ø0.9					