

NOTES:

1. ELEMENT A: 45209
2. ELEMENT B: 32309

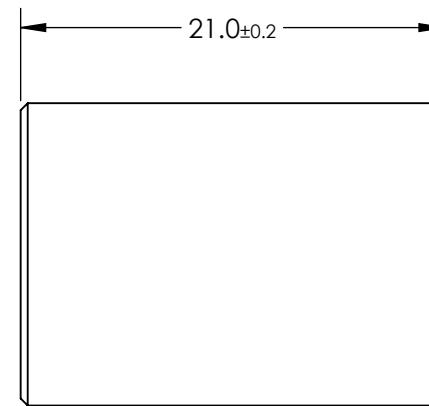
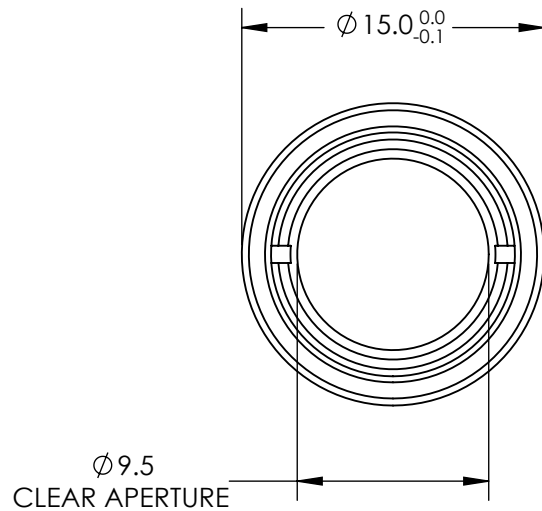
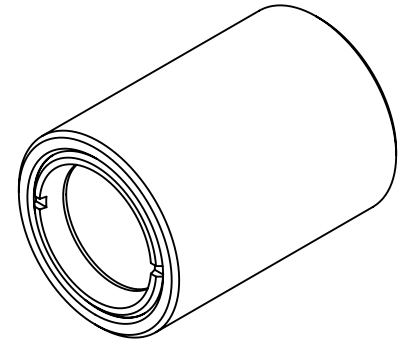

SPECIFICATIONS SUBJECT TO CHANGE WITHOUT NOTICE
DIMENSIONS ARE FOR REFERENCE ONLY

**FOR INFORMATION ONLY:
DO NOT MANUFACTURE
PARTS TO THIS DRAWING**

EO® Edmund Optics®

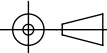
THIRD ANGLE PROJECTION 		TITLE	1:1.43 WITH 14mm AND 20mm EFL ACHROMATS, 15mm ACHROMATIC PAIR	
ALL DIMS IN	mm	DWG NO	43993	SHEET 1 OF 1