

NOTES:

1. SUBSTRATE MATERIAL:
RUBY DOPED SAPPHIRE (Al₂O₃)
2. COATING - NONE
3. FINISH: POLISHED
4. SPHERICITY:
0.64μm
5. RoHS COMPLIANT

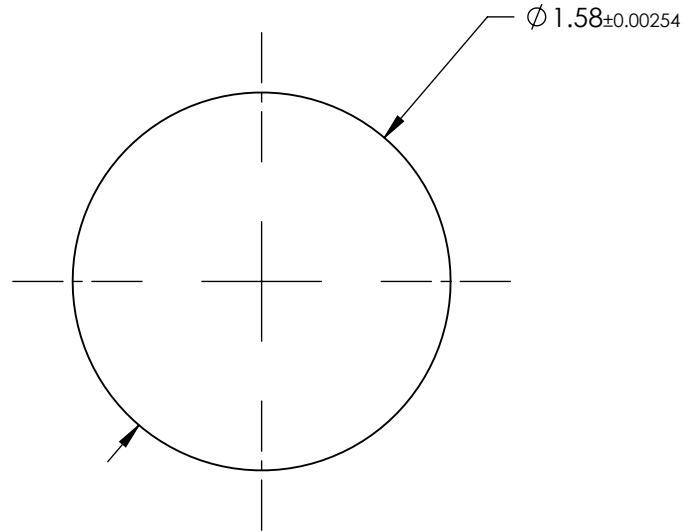

SPECIFICATIONS SUBJECT TO CHANGE WITHOUT NOTICE
DIMENSIONS ARE FOR REFERENCE ONLY

**FOR INFORMATION ONLY:
DO NOT MANUFACTURE
PARTS TO THIS DRAWING**

EO® Edmund Optics®

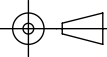
THIRD ANGLE PROJECTION 		TITLE	1.58mm DIAMETER, RUBY BALL LENS	
ALL DIMS IN	mm	DWG NO	46227	SHEET 1 OF 1