

NOTES:

1. SUBSTRATE:  
FUSED SILICA MOUNTED IN BLACK ANODIZED ALUMINUM RING
2. TRANSMITTED WAVEFRONT ERROR:  $\lambda/4$
3. RoHS: COMPLIANT

**FOR INFORMATION ONLY:  
DO NOT MANUFACTURE  
PARTS TO THIS DRAWING**

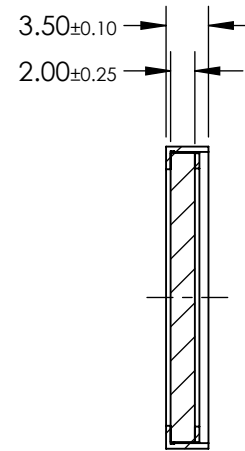
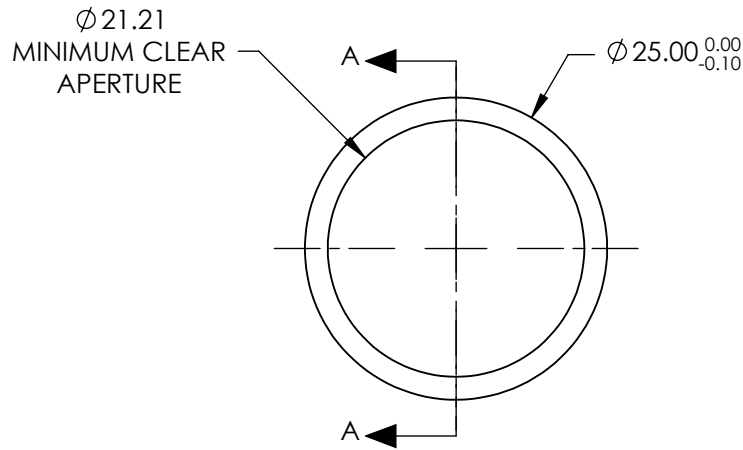

SECTION A-A

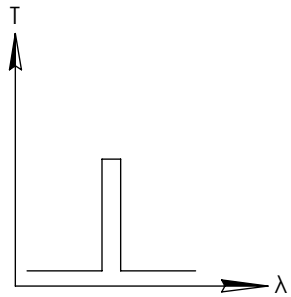

BANDPASS FILTER

	VALUE
CENTER WAVELENGTH (CWL) (nm)	$710 \pm 2$
MINIMUM BANDWIDTH (nm)	40
FULL WIDTH HALF MAX (FWHM) (nm)	47
MINIMUM TRANSMISSION (%)	>93
OD6 BLOCKING RANGE (nm)	250 - 666 & 745 - 940
SURFACE QUALITY	60-40
COATING TYPE	HARD COATED
DURABILITY	MIL-C-48497A, SECT. 3.4.1
ENVIRONMENTAL	MIL-STD-801F, SECT. 507.4

SPECIFICATIONS SUBJECT TO CHANGE WITHOUT NOTICE  
DIMENSIONS ARE FOR REFERENCE ONLY

**EO**® Edmund Optics®

THIRD ANGLE  
PROJECTION

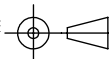

TITLE

OD6,  $\varnothing 25$ mm, 710nm x 47nm, BP  
FLUORESCENCE FILTER

ALL DIMS IN

mm

DWG NO

84104

SHEET  
1 OF 1