

NOTES:

1. SUBSTRATE: ND FILTER GLASS
2. SURFACE S2 TO BE PARALLEL WITH SURFACE S1 TO WITHIN 5 arcsec

3. FINE GRIND SURFACE

4. POWER, IRREGULARITY, AND SURFACE QUALITY SPECIFICATIONS APPLY ACROSS CLEAR APERTURE

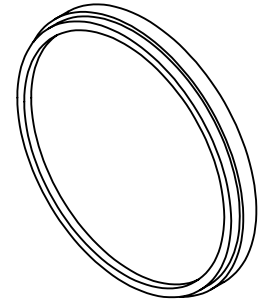

**FOR INFORMATION ONLY:
DO NOT MANUFACTURE
PARTS TO THIS DRAWING**

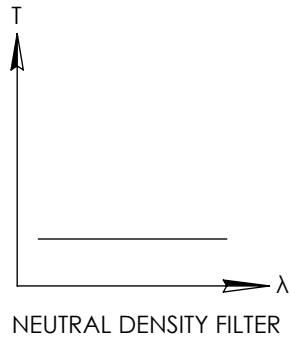
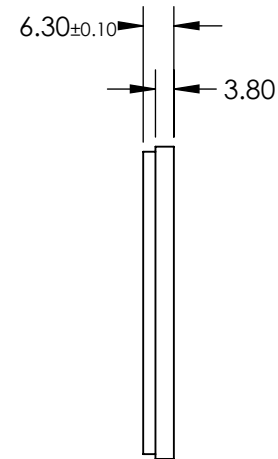
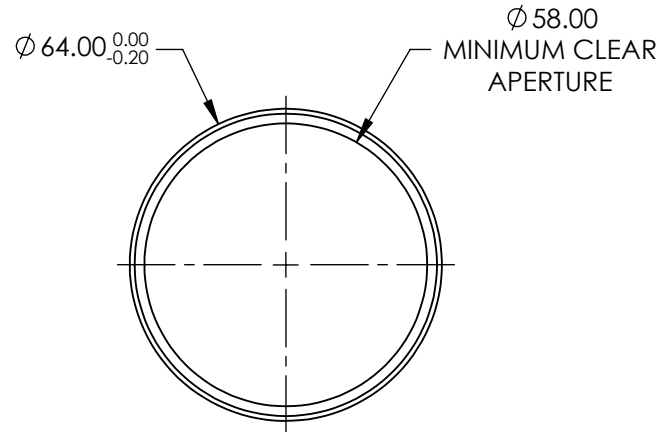

SPECIFICATIONS SUBJECT TO CHANGE WITHOUT NOTICE
DIMENSIONS ARE FOR REFERENCE ONLY

EO® Edmund Optics®

	S1	S2
SHAPE	PLANO	PLANO
SURFACE QUALITY	80-50	80-50
CLEAR APERTURE	$\phi 58$	$\phi 58$
BEVEL	PROTECTIVE AS NEEDED	PROTECTIVE AS NEEDED

THIRD ANGLE PROJECTION

ALL DIMS IN mm

TITLE	OD 0.9, M62.0 X 0.75 MOUNTED ABSORPTIVE ND FILTER		
DWG NO	65023	SHEET	1 OF 1