

NOTES:

1. SUBSTRATE:
GRADE A FINE ANNEALED
SCHOTT: N-BK7 517/642
2. ROHS COMPLIANT
3. CENTERING TOLERANCE (AT 587.6nm):
BEAM DEVIATION (HALF ANGLE): <1 ARCMIN
4. COATING (APPLY ACROSS COATING APERTURE)
S1 & S2: NIR II
R(ABS) ≤ 1.5% FROM 750-800nm @ 0° AOI
R(ABS) ≤ 1.0% FROM 800-1550nm @ 0° AOI
R(AVG) ≤ 0.7% FROM 750-1550nm @ 0° AOI

5. FINE GRIND SURFACE

6. POWER, IRREGULARITY, AND SURFACE QUALITY SPECIFICATIONS APPLY ACROSS CLEAR APERTURE

7. FOCAL LENGTH (EFL): 24.00mm±1%
BACK FOCAL LENGTH (BFL): 22.15mm

8. PROTECTIVE BEVEL AS NEEDED

9. DESIGN WAVELENGTH: 587.6nm

10. BLACKENED SURFACE

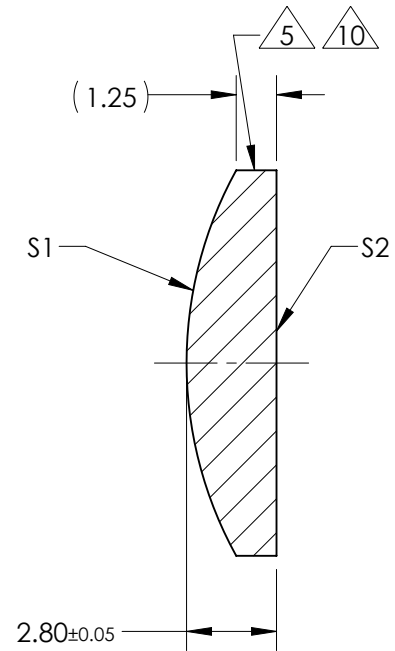
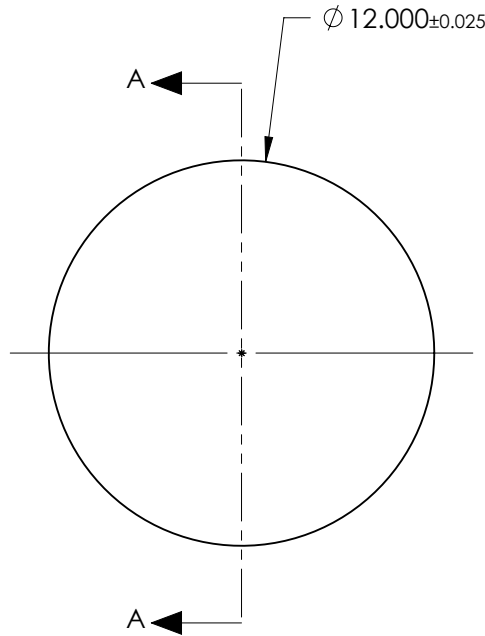

SECTION A-A

**FOR INFORMATION ONLY:
DO NOT MANUFACTURE
PARTS TO THIS DRAWING**

	S1	S2
SHAPE	CONVEX	PLANO
RADIUS	12.42	INFINITY
SURFACE QUALITY	40 - 20	40 - 20
MIN CLEAR APERTURE	∅ 11.00	∅ 11.00
MIN COATING APERTURE	∅ 11.00	∅ 11.00
POWER AT 632.8nm	3.00 RINGS	3.00 RINGS
IRREGULARITY AT 632.8nm	0.50 RINGS	0.50 RINGS

SPECIFICATIONS SUBJECT TO CHANGE WITHOUT NOTICE
DIMENSIONS ARE FOR REFERENCE ONLY

EO® Edmund Optics®

THIRD ANGLE PROJECTION		TITLE	12.0mm Dia. x 24.0mm FL, NIR II, Inked, Plano-Convex Lens
ALL DIMS IN	mm	DWG NO	67497INK
			SHEET 1 OF 1