

NOTES:

1. FILTER THREAD: M30.5 x 0.5 WITH REQUIRED ADAPTER #89-942

(2) M3 SET SCREWS WITH NYLON TIPS
FOR OPTIONAL FOCUS LOCKING
@ 120° FROM LOCK KNOB

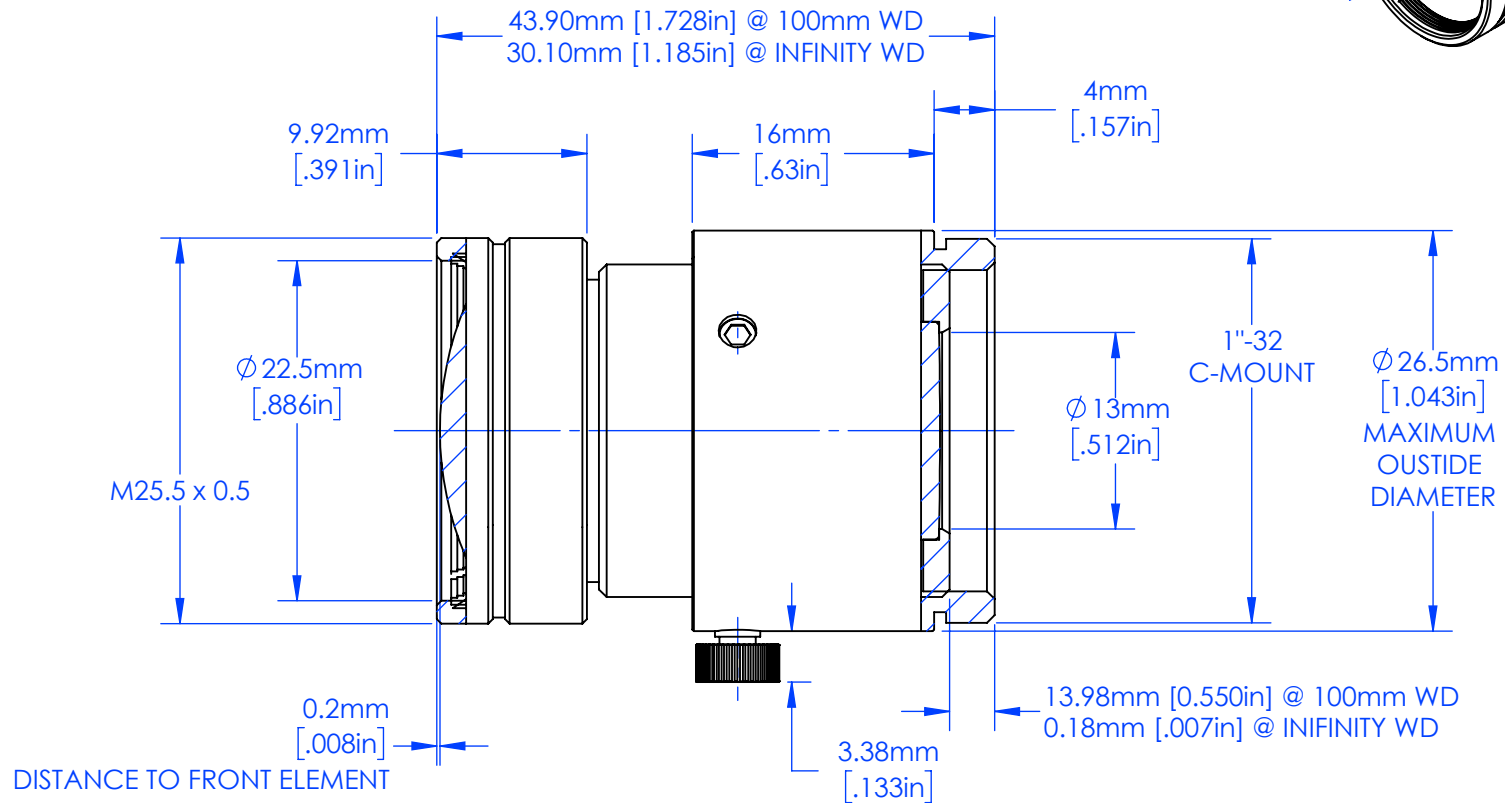
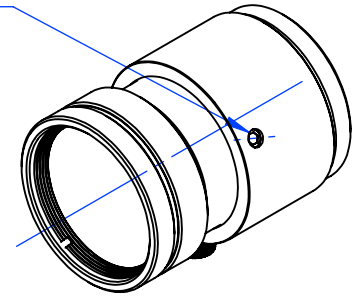

**FOR INFORMATION ONLY:
DO NOT MANUFACTURE
PARTS TO THIS DRAWING**

SPECIFICATIONS SUBJECT TO CHANGE WITHOUT NOTICE. DIMENSIONS ARE FOR REFERENCE ONLY. FOR DETAILED SPECIFICATIONS, PLEASE REFER TO THE SPEC SHEET.

EO® Edmund Optics®

TITLE	35mm, f/4 Ci Series Fixed Focal Length Lens	
DWG NO	85365	SHEET 1 OF 1