

(2) M3 SET SCREWS WITH NYLON TIP
FOR OPTIONAL FOCUS LOCKING
@ 120° FROM LOCK KNOB

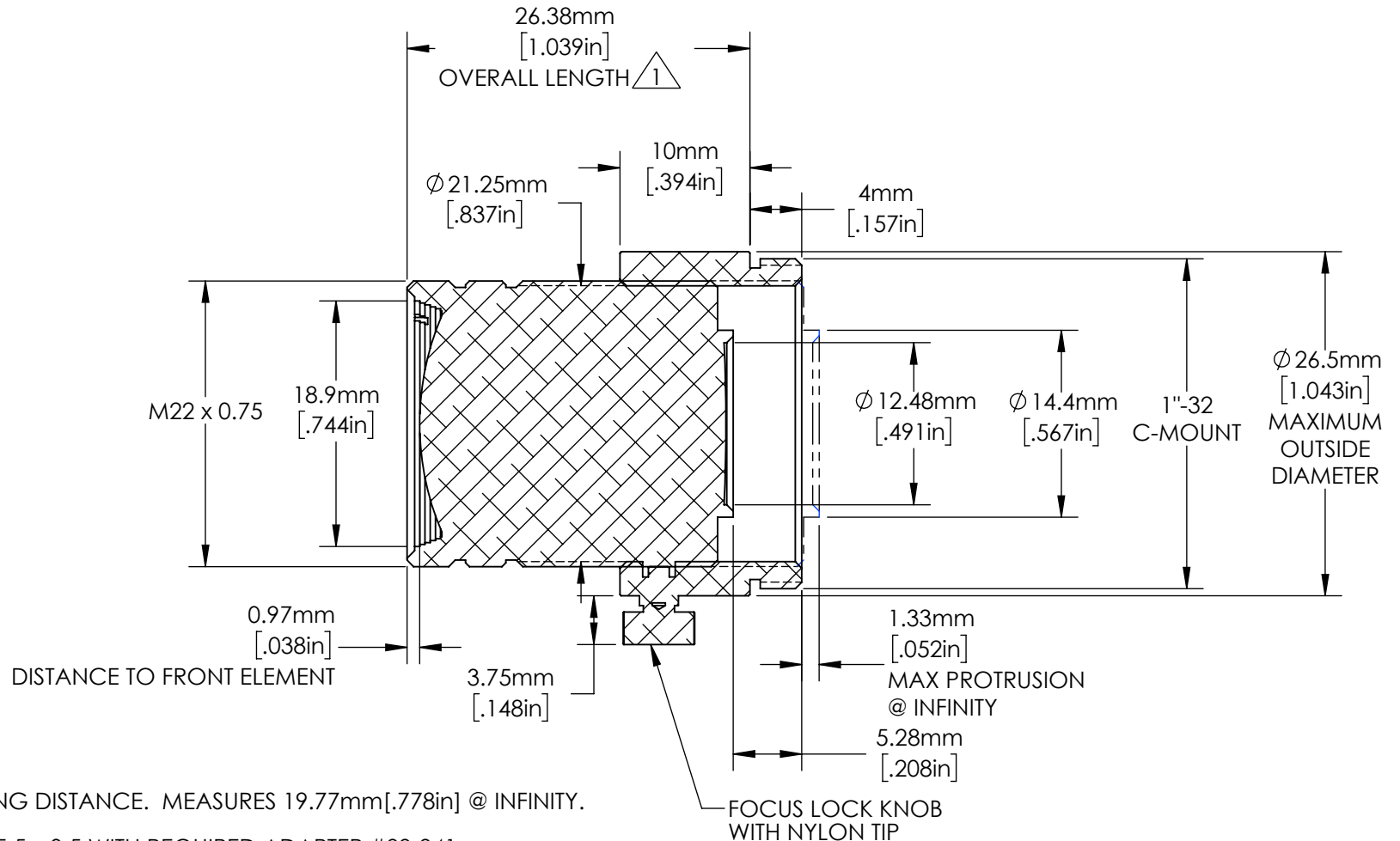

NOTES:

¹ @ 100mm WORKING DISTANCE. MEASURES 19.77mm [.778in] @ INFINITY.

2. FILTER THREAD: M25.5 x 0.5 WITH REQUIRED ADAPTER #89-941

ALIGNED SECTION VIEW

**FOR INFORMATION ONLY:
DO NOT MANUFACTURE
PARTS TO THIS DRAWING**

SPECIFICATIONS SUBJECT TO CHANGE WITHOUT NOTICE. DIMENSIONS ARE FOR REFERENCE ONLY. FOR DETAILED SPECIFICATIONS, PLEASE REFER TO THE SPEC SHEET.



TITLE	25mm, f/1.4 Ci Series Fixed Focal Length Lens	
DWG NO	85355	
		SHEET 1 OF 1